

**The
SOLUTIONS**

[Operation Switch]

Must read! Before Using a Switch

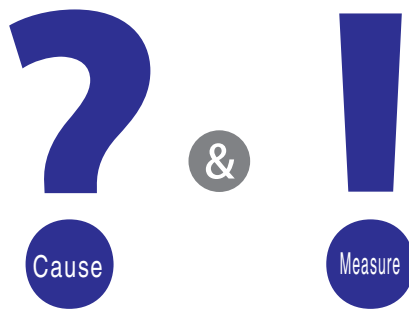

Let's Prolong Switch Life by Preventing Failures!

Introduction

We would like to thank you for using our switches.

We started to develop switches over half a century ago. In order to do everything possible to meet the needs of our customers, we have been committed to various types of switch development and quality improvement.

We are pleased to inform you that our switches have been used for equipment/devices in various applications, and we shipped about a billion switches in one year (actual figure in FY2016 by our research).

We appreciate selecting and continuing to use our products.

We summarized preventive measures against failures in this guide so that customers will use our switches more safely.

We appreciate if The Solution would be helpful in preventive/corrective actions when malfunction occurs.

We are going to meet our customers' needs by focusing on core technologies, and appreciate your continued business.

Notes

- "The Solution" introduces some typical examples of failures found by our customers.
Please understand some cases may not apply to "The Solution".
- If you check the switch by yourself before requesting our analyzation, please check only the appearance and operation, and return it to us without disassembling it (Ex, open the cover).
Please note that if you disassemble a switch (ex, open the cover), we may not be able to investigate the true cause.

Table of Contents

Tactile Switch [PCB mounted type] (B3F, B3M, B3W, B3WN)	
■The mechanism of failure occurrence	A-1
●Non-sealed type	
If foreign materials adhere...	A-3
If flux adheres...	A-4
If an excessive external force is applied...	A-5
If there is a source of sulfuric gas...	A-7
If excessive soldering heat is applied...	A-9
●Sealed type	
If an excessive external force is applied...	A-11
If there is a source of sulfuric gas...	A-13
If excessive soldering heat is applied...	A-15

Tactile Switch [Surface mounted type] (B3FS, B3U, B3S, B3SN, B3SL)	
■The mechanism of failure occurrence	B-1
●Non-sealed type	
If foreign materials adhere...	B-3
If flux adheres...	B-4
If an excessive external force is applied...	B-5
If there is a source of sulfuric gas...	B-7
If excessive soldering heat is applied...	B-9
●Sealed type	
If an excessive external force is applied...	B-11
If excessive soldering heat is applied...	B-13

Rocker Switch (A8L, A8A, A8G, A8GS)	
■The mechanism of failure occurrence	C-1
If foreign materials adhere...	C-3
If flux adheres...	C-4
If overcurrent flows...	C-5
If excessive soldering heat is applied...	C-7
If an excessive external force is applied to the terminal...	C-8
If there is a source of sulfuric gas...	C-9

DIP Switch	
■The mechanism of failure occurrence	D-1
●Slide DIP Switch (A6H, A6HF, A6SH, A6SN, A6T, A6TN, A6D, A6E-N)	
If flux adheres...	D-3
If excessive soldering heat is applied...	D-5
If an excessive external force is applied...	D-7
If a actuator is at the middle between ON and OFF when soldering...	D-9
●Piano DIP Switch (A6HR, A6SR, A6TR, A6DR, A6FR)	
If flux adheres...	D-11
If excessive soldering heat is applied...	D-13
If a lever is at the middle between ON and OFF when soldering...	D-15
●Rotary DIP Switch (A6K / A6K□, A6R / A6R□, A6A, A6C / A6CV)	
If flux adheres...	D-17
If a rotor is at the middle between ON and OFF when soldering...	D-19
If an excessive external force is applied...	D-20

Reference material	
Soldering procedure	E-1

PCB Mounted Type Tactile Switch Mechanism of Failure Occurrence

■Non-sealed type

Cause/reason	Possible failures when using the switch
Foreign materials such as dusts adhere on switch	<ul style="list-style-type: none"> <Contact failure> Contact doesn't turn ON Contact resistance value is high (unstable)
Flux adheres on switch	<ul style="list-style-type: none"> <Contact failure> Contact doesn't turn ON Contact resistance value is high (unstable)
The excessive external force is applied to switch	<ul style="list-style-type: none"> <Appearance failure> Plunger is broken or leaning <Contact failure> Contact keeps ON <Operation failure> No click feeling
Source of sulfuric gas around switch	<ul style="list-style-type: none"> <Appearance failure> Discoloration in the terminals <Contact failure> Contact doesn't turn ON Contact resistance value is high (unstable) <Soldering failure> Terminals cannot be soldered
The excessive soldering heat is applied to switch	<ul style="list-style-type: none"> <Contact failure> Contact doesn't turn ON <Operation failure> No click feeling

■Sealed type

Cause/reason	Possible failures when using the switch
The excessive external force is applied to switch	<ul style="list-style-type: none"> <Appearance failure> Plunger is broken or leaning <Contact failure> Contact keeps ON <Operation failure> No click feeling
Source of sulfuric gas around switch	<ul style="list-style-type: none"> <Appearance failure> Discoloration in the terminals <Contact failure> Contact doesn't turn ON Contact resistance value is high (unstable) <Soldering failure> Terminals cannot be soldered
The excessive soldering heat is applied to switch	<ul style="list-style-type: none"> <Contact failure> Contact doesn't turn ON <Operation failure> No click feeling

■Non-sealed type

B3F



B3M



■Sealed type

B3W



B3WN



Direct causes leading to failures

Foreign materials adhere on contact surface

Flux adheres on contact surface

Plunger or contact dome is damaged due to an external force

Sulfurization of contact surface
Sulfurization of terminal surface

The resin around the contact is rising
The position of the contact changes

Checkpoint for prevention (measures)

Be sure not to adhere foreign matters when storing, mounting and using switch.
Consider sealed type switch.

Be sure not to adhere flux on switch when soldering.
Do not wash this switch.

Be sure not to apply any force on the plunger from a direction other than operating direction.
Also, do not operate the plunger with excessive force.

Store switch under appropriate environment.
Be sure to use switch in the place without source of sulfuric gas/sulfuric hydrogen gas.

Be sure to solder within the soldering condition recommended by Omron.

Direct causes leading to failures

Plunger or contact dome is damaged due to an external force

Sulfurization of contact surface
Sulfurization of terminal surface

The resin around the contact is rising
The position of the contact changes

Checkpoint for prevention (measures)

Be sure not to apply any force on the plunger from a direction other than operating direction.
Also, do not operate the plunger with excessive force.

Store switch under appropriate environment.
Be sure to use switch in the place without source of sulfuric gas/sulfuric hydrogen gas.

Be sure to solder under the soldering condition recommended by Omron.

[If foreign matters adhere...]

■What are the possible failures?



<Contact failure>

Contact doesn't turn ON

Contact resistance value is high (unstable)

■The failure case

- Foreign materials entered through an upper gap of switch, adhere to the contact and contact failure results.
e.g.) B3F

Appearance

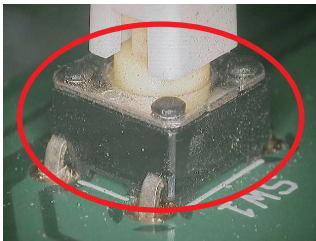

Dust adherence

Inside the base



Dusts enter through a gap between the plunger and the cover

Contact dome



Dusts adhere to the contact surface, and contact failure results

■Checkpoint for prevention!



Do you find any foreign material such as dust/board powder around switch?

Since this switch is non-sealed type, it's impossible to prevent foreign material and liquid from entering completely.

Make sure that no foreign materials adhere when storing/mounting/using a switch.

Because preventing dust from being produced is difficult, please consider using sealed type switches (B3W, B3WN), or dust-resistant covers etc.

[If flux adheres...]

■What are the possible failures?



<Contact failure>
 Contact doesn't turn ON
 Contact resistance value is high (unstable)

■The failure case

●The flux entered inside, adheres to the contact and contact failure results.

e.g.) B3F

<UV irradiation check>

* When flux is irradiated with UV, it fluoresces.

Upper part of switch (cover)

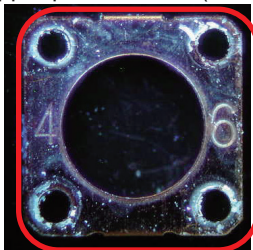

Flux adherence

Inside the base

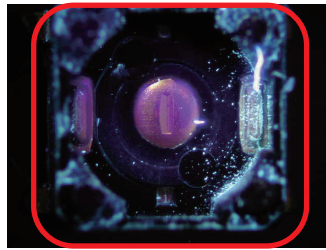

Flux enters through an upper gap of the switch

Contact dome



Flux adheres to the contact surface, and it causes a contact failure

■Checkpoint for prevention!



Is switch soldering condition under our recommended condition?

Solder switches follow the conditions below.

Also, make sure that flux doesn't scatter and adhere to switch.

●Automatic soldering baths

(1) [Preheating]

Temperature: 100°C max.

Time: 60s max.

[Heating (soldering)]

Temperature: 260°C max.

Time: 5s max.

(2) Please make sure that no flux will rise above the level of the PCB on the side where switch is mounded.

●Manual soldering

(1) Soldering temperature: 350°C max. at the tip of the soldering iron

Soldering time: 3s max.

(2) Before soldering the switch on a PCB, make sure that there is no unnecessary space between switch and PCB.

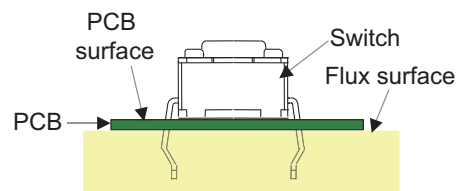

Are not washing the Switch after soldering?

B3F and B3M are models that cannot be washed.

Washing may cause flux or dust particles on the PCB to enter into the Switch.

Washable (sealed types)	B3W, B3SN, B3S, B3WN
Non-washable (sealed type)	B3F, B3FS, B3SL, B3W-9, B3J, B3M, B3U, B3AL

[If an excessive external force is applied...]

■What are the possible failures?



- <Appearance failure>
Plunger is broken or leaning
- <Contact failure>
Contact keeps ON
- <Operation failure>
No click feeling

■The failure case

- If an excessive external force is applied to a plunger from a horizontal and slanted direction, it will damage the plunger and appearance failure/operation failure results.
e.g.) B3F

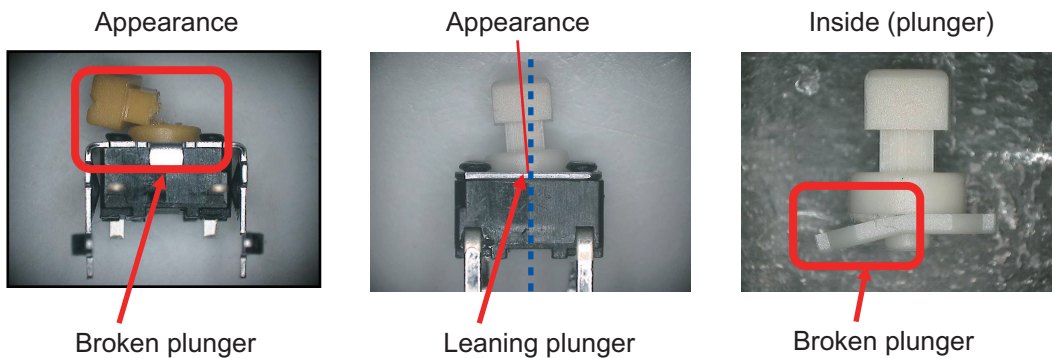

- If an excessive external force is applied to a plunger vertically from above, it will deform the contact dome and operation failure/contact failure results.
e.g.) B3F

NG switch X-ray

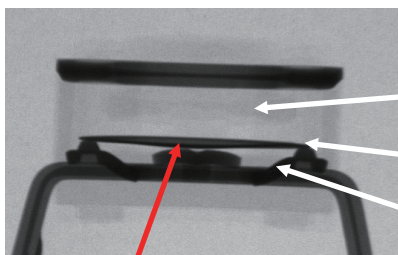

OK switch X-ray

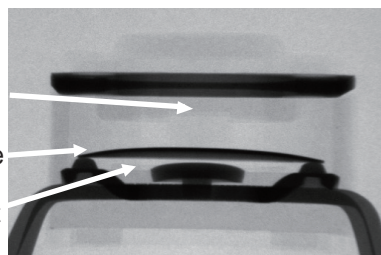

Because the contact dome was deformed, it was reversed, and then it doesn't return while fixed contact touches. (Contact keeps turning on)

■ **Checkpoint for prevention!**



Is the force applied to the plunger from a direction other than operating direction?

Be sure to set up switch so that the plunger will operate vertically.
A decrease in the life of switch may result if the plunger is pressed off-center or from slanted direction.

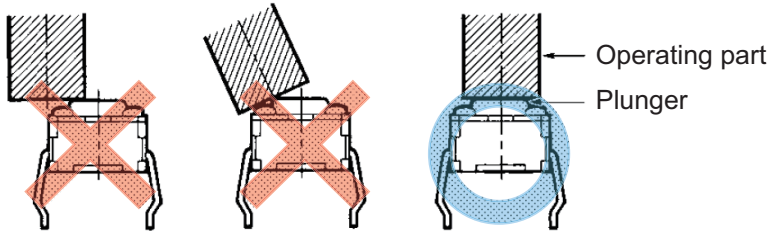

Is an excessive operating force applied to the plunger?

Do not operate switch with excessive force over and over again.
Applying excessive pressure or additional force with the plunger pushed may deform the contact dome, and operation failure results.
In particular, applying excessive force to side-operated switches (B3F-3000 series) may damage the caulking, which may damage switch.
Do not apply force exceeding the maximum (29.4 N for 1 minute, one time) when installing or using switches.

[If sulfuric gas generates...]

■What are the possible failures?



- <Appearance failure>
Discoloration in the terminals
- <Contact failure>
Contact doesn't turn ON, contact resistance value is high (unstable)
- <Soldering failure>
Terminals cannot be soldered

■The failure case

- The terminal is discolored by sulfurization and cannot be soldered. Also, the contact sulfurization results in conduction failure.

e.g.) B3F

Appearance

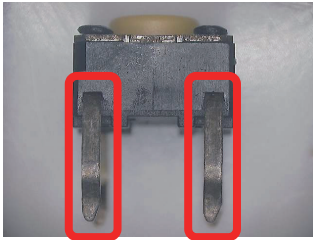

Terminals are discolored to black and cannot be soldered due to sulfurization

Inside the base



Contact parts are discolored to black due to sulfurization

Contact dome



The contact part is discolored to black due to sulfurization

■Checkpoint for prevention!



Are the storage environment and condition appropriate?

●Storage environment

To prevent degradation such as discoloration in the terminals during storage, do not store switches in locations that are subject to the following conditions:

- (1) High temperature or humidity
- (2) Corrosive gases
- (3) Direct sunlight

●Storage condition

Store switches in the packaging or box.

Please use switches as quickly as possible after packaging or box is opened

When storing leftover parts, make sure that appropriate measures are taken against humidity and corrosive gases.



Has sulfuric gas or sulfuric hydrogen gas existed around switches?

When sulfuric gas or sulfuric hydrogen gas exists, it can cause corrosive damage to the contacts and malfunction results.

Please don't use in areas subject to toxic gases.

- As a source of sulfuric gas, the following examples can be mentioned:

[Source]

Car exhaust gas, gypsum board, wood, papers such as cardboard, fiber scraps, seawater, dirt, sludge, volcanic gas, hot springs, etc.

[Occurrence Place]

Storage warehouse for gypsum, sewage / wastewater treatment plants, garbage disposal plants, abandoned site, petroleum refining

Also, if there is less oxygen or no oxygen, and if it is humid, we judge that sulfuric gas is generated.

Injecting oxygen is the most effective to suppress the generation of sulfuric hydrogen gas.

In addition, eliminating the source of gas generation and making dry state is also effective.

[If excessive soldering heat is applied...]

■What are the possible failures?



- <Contact failure>
Contact doesn't turn ON
- <Operation failure>
No click feeling

■The failure case

- Resin of the base is melted, and operation failure/contact failure will result.
e.g.) B3F

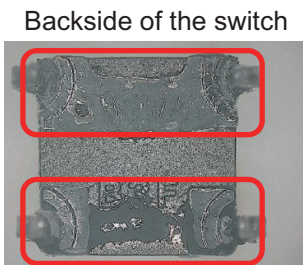

The resin is melted

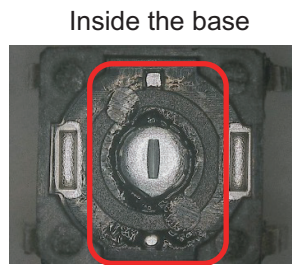

The resin is melted



The resin around the contact is puffed up because it is melted, so it doesn't work properly

■Checkpoint for prevention!



Is switch soldering condition under our recommended condition?

Solder switches by following the conditions below.

Do not solder switch more than twice, including rectification soldering.

An interval of five minutes is required between the first and the second soldering to bring it back to room temperature.

●Automatic soldering baths

- | | |
|-------------------------|-------------------------|
| (1) [Preheating] | [Heating (soldering)] |
| Temperature: 100°C max. | Temperature: 260°C max. |
| Time: 60s max. | Time: 5s max. |

- (2) Please make sure that no flux will rise above the level of the PCB on the side where switch is mounted.

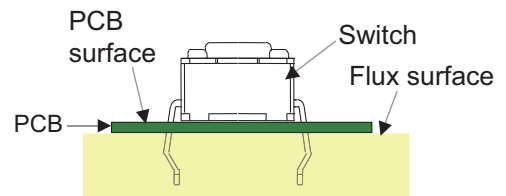

●Manual soldering

- (1) Soldering temperature: 350°C max. at the tip of the soldering iron
Soldering time: 3s max.
- (2) Before soldering switch on a PCB, make sure that there is no unnecessary space between switch and PCB.



Is soldering method appropriate?

Please refer to Soldering procedure on page E-1.

[If an excessive external force is applied...]

■What are the possible failures?



<Appearance failure>

The Switch is disassembled, the height of the plunger is low

<Contact failure>

Contact keeps ON

<Operation failure>

No click feeling

■The failure case

- If an excessive external force is applied on a plunger from an angle/horizontally, it will damage the plunger and appearance failure/operation failure will result.
e.g.) B3W e.g.) B3WN

Appearance

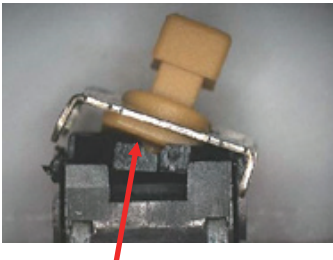

The plunger is leaning, and the cover is off

Appearance

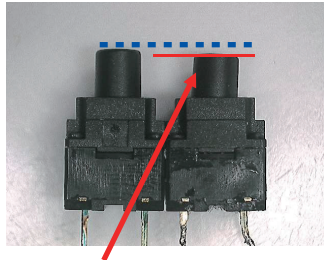

The height of the plunger is low

Inside (plunger)

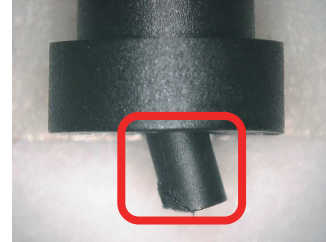

Deformed plunger

- If an excessive external force is applied on a plunger vertically from above, it will deform the contact dome and operation failure/contact failure will result.
e.g.) B3W

NG switch contact dome

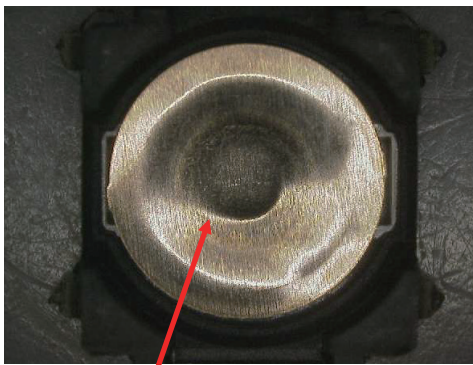

Because the contact dome was deformed, when it was reversed, it doesn't return, and touches the fixed contact

OK switch contact dome

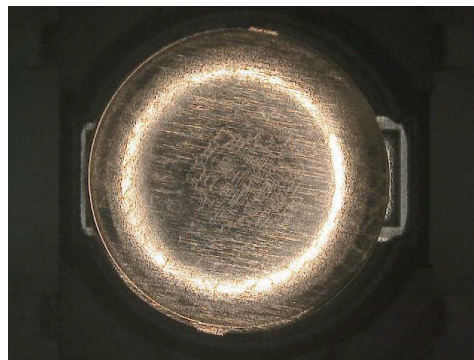

■ **Checkpoint for prevention!**



Is the force applied to the plunger from a direction other than operating direction?

Be sure to set up switch so that the plunger will operate in a straight vertical line.

A decrease in the life of switch may result if the plunger is pressed off-center or from an angle.

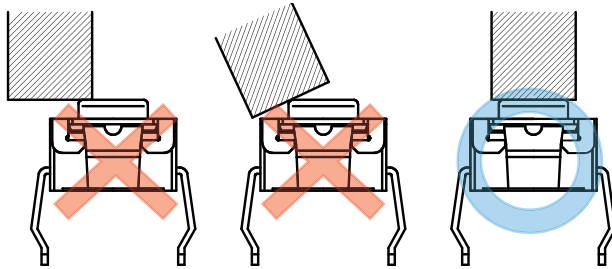

Is an excessive operating force applied to the plunger?

Do not operate switch with excessive force over and over again.

Applying excessive pressure or additional force with the plunger pushed may deform the contact dome, and operation failure results.

Do not apply force exceeding the maximum (29.4 N for 1 minute, one time) when installing or using switches.

[If sulfuric gas generates...]

■What are the possible failures?



- <Appearance failure>
Discoloration in the terminals
- <Soldering failure>
Terminals cannot be soldered

■The failure case

- The terminal is discolored by sulfurization and cannot be soldered.

e.g.) B3W

Appearance

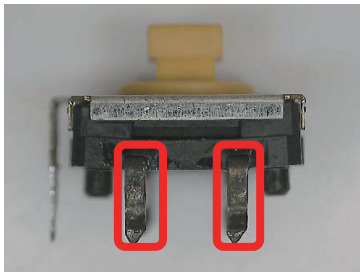

Terminals are discolored to black and cannot be soldered due to sulfurization

e.g.) B3WN

Appearance

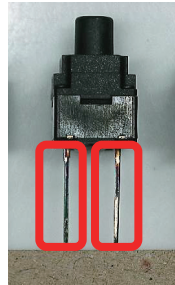

Terminals are discolored to black and cannot be soldered due to sulfurization

■Checkpoint for prevention!



Are the storage environment and condition appropriate?

●Storage environment

To prevent degradation such as discoloration in the terminals during storage, do not store switches in locations that are subject to the following conditions:

- (1) High temperature or humidity
- (2) Corrosive gases
- (3) Direct sunlight

●Storage condition

Store switches in the packaging or box.

Please use switches as quickly as possible after packaging or box is opened

When storing leftover parts, make sure that appropriate measures are take against humidity and corrosive gases.



Has sulfuric gas or sulfuric hydrogen gas existed around switches?

When sulfuric gas or sulfuric hydrogen gas exists, it can cause corrosive damage to the contacts and malfunction results.

Please don't use in areas subject to toxic gases.

- As a source of sulfuric gas, the following examples can be mentioned:

[Source]

Car exhaust gas, gypsum board, wood, papers such as cardboard, fiber scraps, seawater, dirt, sludge, volcanic gas, hot springs, etc.

[Occurrence Place]

Storage warehouse for gypsum, sewage / wastewater treatment plants, garbage disposal plants, abandoned site, petroleum refining

Also, if there is less oxygen or no oxygen, and if it is humid, we judge that sulfuric gas is generated. Injecting oxygen is the most effective to suppress the generation of sulfuric hydrogen gas. In addition, eliminating the source of gas generation and making dry state is also effective.

[If excessive soldering heat is applied...]

■What are the possible failures?



<Contact failure>
Contact doesn't turn ON
<Operation failure>
No click feeling

■The failure case

- Resin of the base is melted and operation failure/contact failure will result.

e.g.) B3W

Side of the switch

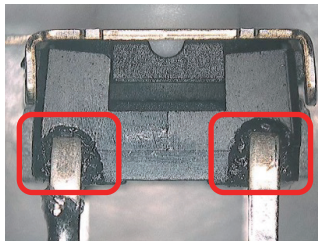

The resin is melted

Inside the base

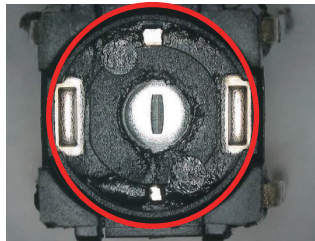

The resin is melted

Center contact of the base

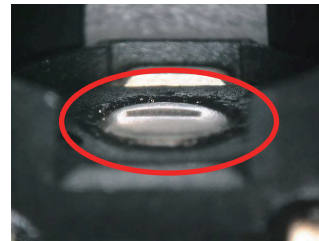

The resin around the contact is puffed up because it is melted, so it doesn't work properly

■Checkpoint for prevention!



Is switch soldering condition under our recommended condition?

Solder switches by following the conditions below.

Do not solder switches more than twice, including rectification soldering.

An interval of five minutes is required between the first and the second soldering to bring it back to room temperature.

●Automatic soldering baths

- | | |
|-------------------------|-------------------------|
| (1) [Preheating] | [Heating (soldering)] |
| Temperature: 100°C max. | Temperature: 260°C max. |
| Time: 60s max. | Time: 5s max. |
- (2) Please make sure that no flux will rise above the level of the PCB on the side where switch is mounted.

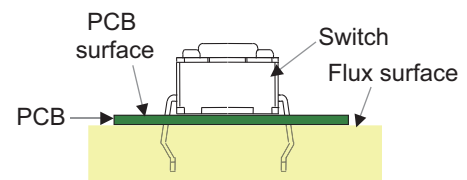

●Manual soldering

- (1) Soldering temperature: 350°C max. at the tip of the soldering iron
Soldering time: 3s max.
- (2) Before soldering the Switch on a PCB, make sure that there is no unnecessary space between switch and PCB.



Is soldering method appropriate?

Please refer to Soldering procedure on page E-1.

Surface Mounted Type Tactile Switch Mechanism of Failure Occurrence

■Non-sealed type

Cause/reason	Possible failures when using the switch
Foreign matters such as dusts adhere to switch	<ul style="list-style-type: none"> <Contact failure> Contact doesn't turn ON Contact resistance value is high (unstable)
Flux adheres to switch	<ul style="list-style-type: none"> <Contact failure> Contact doesn't turn ON Contact resistance value is high (unstable)
The excessive external force is applied to switch	<ul style="list-style-type: none"> <Appearance failure> Plunger is broken or leaning <Contact failure> Contact keeps ON <Operation failure> No click feeling
Source of sulfuric gas around switch	<ul style="list-style-type: none"> <Appearance failure> Discoloration in the terminals <Contact failure> Contact doesn't turn ON Contact resistance value is high (unstable) <Soldering failure> Terminals cannot be soldered
The excessive soldering heat is applied to switch	<ul style="list-style-type: none"> <Contact failure> Contact doesn't turn ON <Operation failure> No click feeling

■Sealed type

Cause/reason	Possible failures when using the switch
The excessive external force is applied to switch	<ul style="list-style-type: none"> <Appearance failure> Plunger is broken or leaning <Contact failure> Contact keeps ON <Operation failure> No click feeling
The excessive soldering heat is applied to switch	<ul style="list-style-type: none"> <Contact failure> Contact doesn't turn ON <Operation failure> No click feeling

■Non-sealed type

B3FS



B3U



■Sealed type

B3S



B3SN



B3SL



Direct causes leading to failures

Foreign matters adhere to contact surface

Flux adheres on contact surface

Plunger or contact dome is damaged because of an external force

Sulfurization of contact surface
Sulfurization of terminal surface

The resin around the contact is puffed up
The position of the contact changes

Checkpoint for prevention (measures)

Be sure not to adhere foreign matters when storing, mounting and using switch.
Consider sealed type switch.

Be sure not to adhere flux to switch when soldering.
Do not wash this switch.

Be sure not to apply any force to the plunger from a direction other than operating direction.
Also, do not operate the plunger with excessive force.

Store switch under appropriate environment.
Be sure to use switch in the place without source of sulfuric gas/sulfuric hydrogen gas.

Be sure to solder within the soldering condition recommended by Omron.

Direct causes leading to failures

Plunger or contact dome is damaged because of an external force

The resin around the contact is puffed up
The position of the contact changes

Checkpoint for prevention (measures)

Be sure not to apply any force on the plunger from a direction other than operating direction.
Also, do not operate the plunger with excessive force.

Be sure to solder within the soldering condition recommended by Omron.

[If foreign matters adhere...]

■What are the possible failures?



<Contact failure>

Contact doesn't turn ON

Contact resistance value is high (unstable)

■The failure case

- Foreign matters entered through an upper gap of switch, adhere to the contact and failure results.

e.g.) B3FS

Appearance shot



Dust adherence

Inside the base

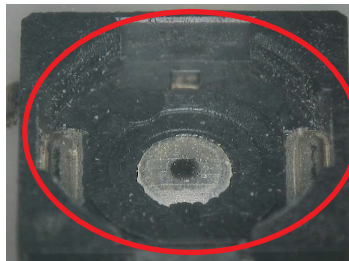

Dusts enter through a gap between plunger and cover

Contact dome



Dusts adhere to the contact surface, and it causes a contact failure

■Checkpoint for prevention!



Do you find any foreign material such as dust/board powder around switch?

Since this switch is non-sealed type, it's impossible to prevent foreign material and liquid from entering completely.

Make sure that no foreign materials adhere when storing/mounting/using a switch.

Because preventing dust from being produced is difficult, please consider using sealed type switches (B3S, B3SN, B3SL), or dust-resistant covers etc.

[If flux adheres...]

■What are the possible failures?



<Contact failure>
 Contact doesn't turn ON
 Contact resistance value is high (unstable)

■The failure case

- The flux entered inside, adheres to the contact and contact failure results.
 e.g.) B3F

<UV irradiation check> * When flux is irradiated with UV, it fluoresces.

Upper part of switch (cover)

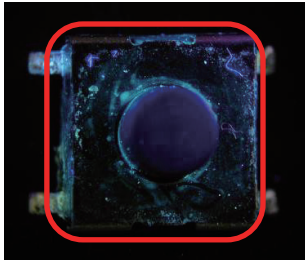

Flux adherence

Inside the base

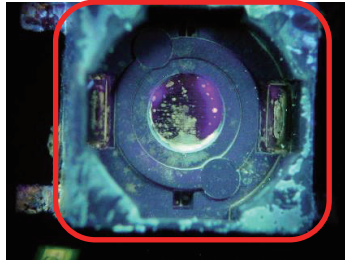

Flux enters through an upper gap of the switch

Contact dome

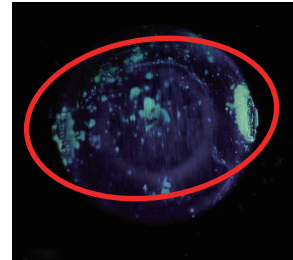

Flux adheres to the contact surface, and it causes a contact failure

■Checkpoint for prevention!



Are you not washing switch after soldering?

B3FS and B3U are models that cannot be washed.

Washing may cause flux or dust particles on the PCB to enter into switch.

Washable (sealed types)	B3W, B3SN, B3S, B3WN
Non-washable (sealed type)	B3F, B3FS, B3SL, B3W-9, B3J, B3M, B3U, B3AL



Is not any scattered flux around switch?

Since this switch is not sealed type, it's impossible to prevent foreign matters and liquid from entering completely.

Be sure not to allow flux to scatter and adhere to switch.

[If an excessive external force is applied...]

■What are the possible failures?



- <Appearance failure>
Switch is disassembled, the plunger is leaning
- <Contact failure>
Contact keeps ON
- <Operation failure>
No click feeling

■The failure case

- If an excessive external force is applied to a plunger from an angle/horizontally, it will damage the plunger and appearance failure/operation failure will result.

e.g.) B3FS

Appearance shot

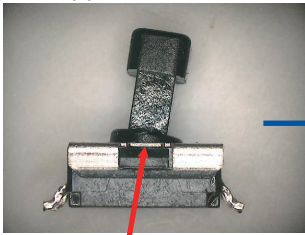

The plunger is leaning

Inside shot (plunger)

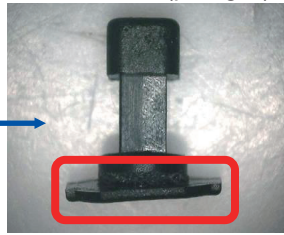

The plunger is damaged

- If an excessive external force is applied to a plunger vertically from above, it will deform contact dome and operation failure/contact failure will result.

e.g.) B3W

NG switch contact dome

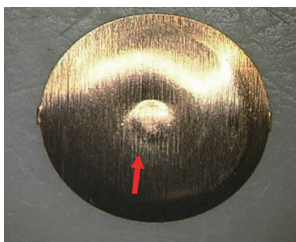

Contact dome is deformed

OK switch contact dome

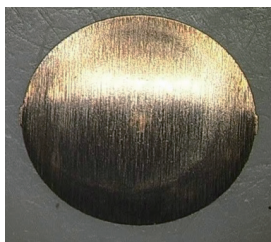

■ Checkpoint for prevention!



Check!

Is the force applied to the plunger from a direction other than operating direction?

Be sure to set up switch so that the plunger will operate in a straight vertical line.
A decrease in the life of switch may result if the plunger is pressed off-center or from an angle.

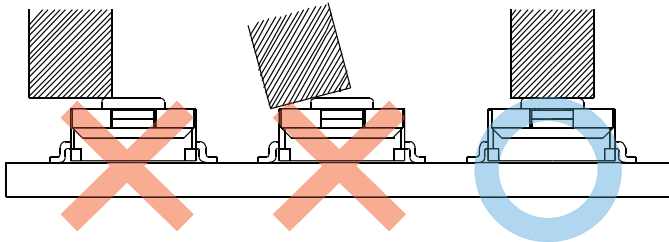

Check!

Is an excessive operating force applied to the plunger?

Do not operate switch with excessive force over and over again.
Applying excessive pressure or additional force with the plunger pushed may deform the contact dome, and operation failure results.
Do not apply force exceeding the maximum (29.4 N for 1 minute, one time) when installing or using switches.

[If sulfuric gas generates...]

■What are the possible failures?



- <Appearance failure>
Discoloration in the terminals
- <Contact failure>
Contact doesn't turn ON, contact resistance value is high (unstable)
- <Soldering failure>
Terminals cannot be soldered

■The failure case

- The terminal is discolored by sulfurization and cannot be soldered. Also, the contact sulfurization results in conduction failure.
e.g.) B3F

Appearance (terminal part)

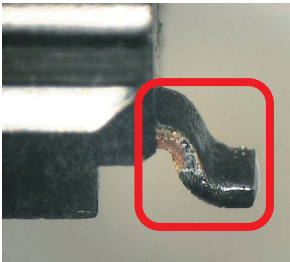

The terminal is discolored to black due to sulfurization

Inside the base

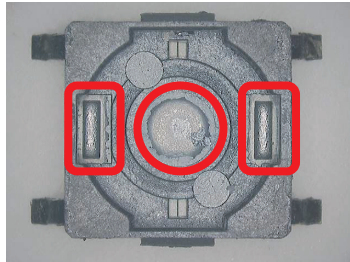

Contact parts are discolored to black due to sulfurization

Contact dome



The contact part is discolored to black due to sulfurization

■Checkpoint for prevention!



Are the storage environment and condition appropriate?

●Storage environment

To prevent degradation such as discoloration in the terminals during storage, do not store switches in locations that are subject to the following conditions:

- (1) High temperature or humidity
- (2) Corrosive gases
- (3) Direct sunlight

●Storage condition

Store switches in the packaging or box.

Please use switches as quickly as possible after packaging or box is opened

When storing leftover parts, make sure that appropriate measures are taken against humidity and corrosive gases.



Has sulfuric gas or sulfuric hydrogen gas existed in environment using switch?

When sulfuric gas or sulfuric hydrogen gas exists, as it will causes to occur functional disorders such as breakdown by contact

- As a source of sulfuric gas, the following example can be mentioned.

[Source]

Car exhaust gas, gypsum board, wood, papers such as cardboard, fiber scraps, seawater, dirt, sludge, volcanic gas, hot springs, etc.

[Occurrence Place]

Storage warehouse for gypsum, sewage / wastewater treatment plants, garbage disposal plants, abandoned site, petroleum refining

Also, if there is less oxygen or no oxygen, and if it is humid, we judge that sulfuric gas is generated.

Injecting oxygen is the most effective to suppress the generation of sulfuric hydrogen gas.

In addition, eliminating the source of gas generation and making dry state is also effective.

[If excessive soldering heat is applied...]

■What are the possible failures?



- <Contact failure>
Contact doesn't turn ON, or keeps ON
- <Operation failure>
No click feeling

■The failure case

- Resin of the base is melted, and operation failure/contact failure will result.

e.g.) B3U

Backside of the switch

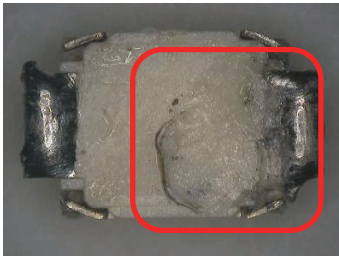

The resin is melted

Inside the base

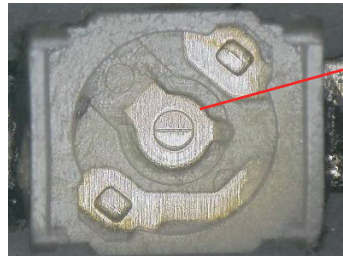

NG switch
Center contact of the base

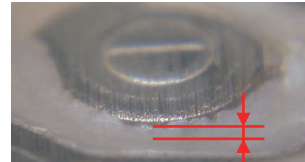

There is unnecessary gap under the center contact, and the contact keeps turning on

OK switch
Center contact of the base

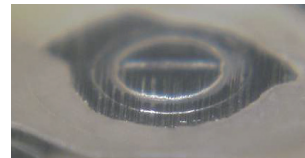

■Checkpoint for prevention!



Is the switch soldering condition under our recommended condition?

Solder switches by following the conditions below.
Do not solder switch more than twice, including rectification soldering.
An interval of five minutes is required between the first and the second soldering to bring it back to room temperature.

●Reflow soldering (surface mounting)

Solder the terminals within the heating curve shown in the diagram on the right.

●Manual soldering

- (1) Soldering temperature: 350°C max. at the tip of the soldering iron
Soldering time: 3s max
- (2) Before soldering the Switch on a PCB, make sure that there is no unnecessary space between the Switch and the PCB.

B3S, B3SN, B3FS

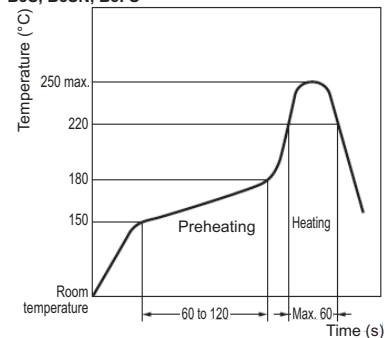

B3SL, B3U, B3AL

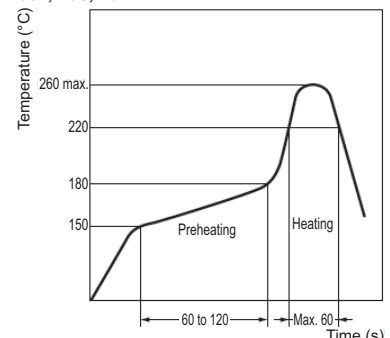

Note: The above heating curve applies if the PCB thickness is 1.6 mm.



Is soldering method appropriate?

Please refer to Soldering procedure on page E-1.

[If an excessive external force is applied...]

■What are the possible failures?



- <Appearance failure>
Switch is disassembled, the plunger is leaning
- <Contact failure>
Contact keeps ON
- <Operation failure>
No click feeling

■The failure case

- If an excessive external force is applied to a plunger from an angle/horizontally, it will damage the plunger and appearance failure/operation failure will result.

e.g.) B3SN

NG switch Appearance

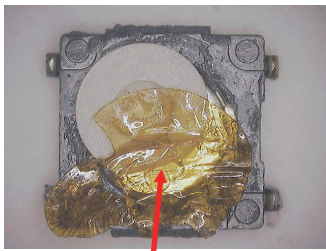

The cover is off, and internal parts are disassembled

OK switch Appearance

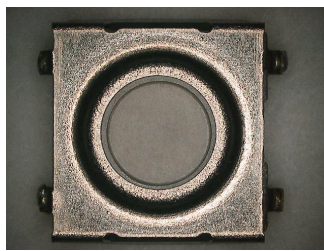

e.g.) B3SL

Appearance

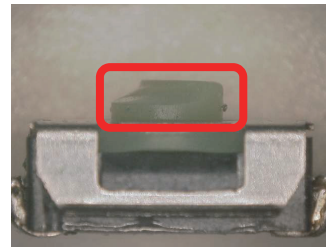

The plunger is cut off

- If an excessive external force is applied on a plunger vertically from above, it will deform the plunger and operation failure/contact failure will result.

e.g.) B3SN

NG switch Plunger

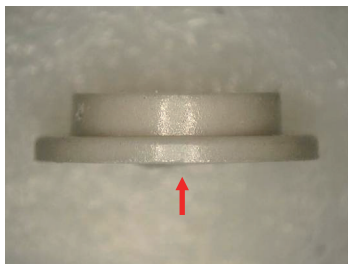

The plunger is crushed and cannot be operated

OK switch Plunger



■ Checkpoint for prevention!



Is the force applied to the plunger from a direction other than operating direction?

Be sure to set up switch so that the plunger will operate in a straight vertical line.
A decrease in the life of switch may result if the plunger is pressed off-center or from an angle.

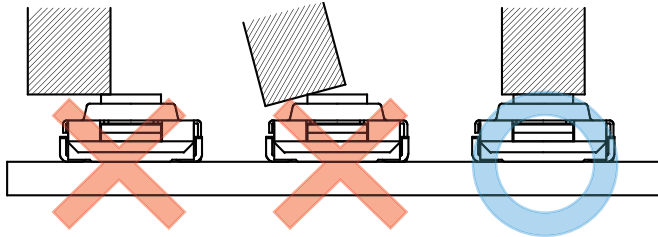

Is an excessive operating force applied to the plunger?

Do not operate switch with excessive force over and over again.
Applying excessive pressure or additional force with the plunger pushed may deform the contact dome, and operation failure results.
Do not apply force exceeding the maximum (29.4 N for 1 minute, one time) when installing or using switches.

[If excessive soldering heat is applied...]

■What are the possible failures?



- <Contact failure>
Contact doesn't turn ON, or keeps ON
- <Operation failure>
No click feeling

■The failure case

- Resin of the base is melted and operation failure/contact failure will result.
e.g.) B3SN

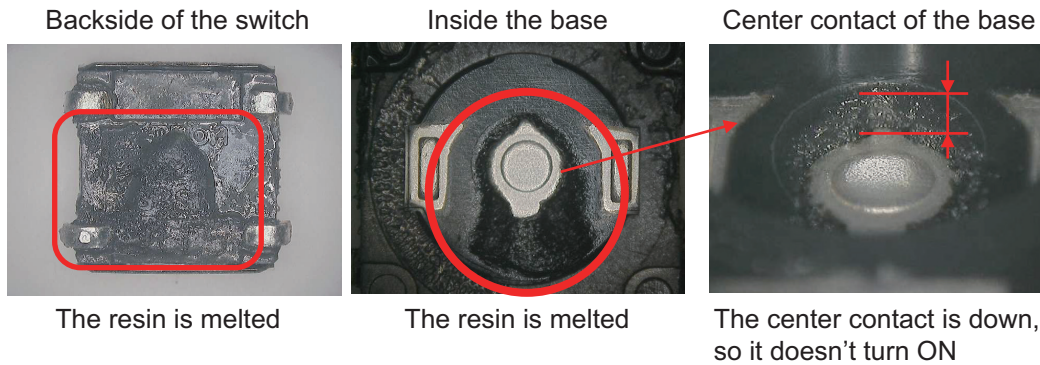

■Checkpoint for prevention!



Does the switch soldering condition conform with our recommended condition?

Solder switches by following the conditions below.
Do not solder switch more than twice, including rectification soldering.
An interval of five minutes is required between the first and the second soldering to bring it back to room temperature.

●Reflow soldering (surface mounting)

Solder the terminals within the heating curve shown in the diagram on the right.

●Manual soldering

- (1) Soldering temperature: 350°C max. at the tip of the soldering iron
Soldering time: 3s max.
- (2) Before soldering the Switch on a PCB, make sure that there is no unnecessary space between the Switch and the PCB.

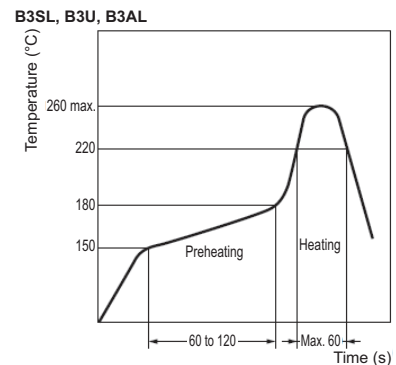
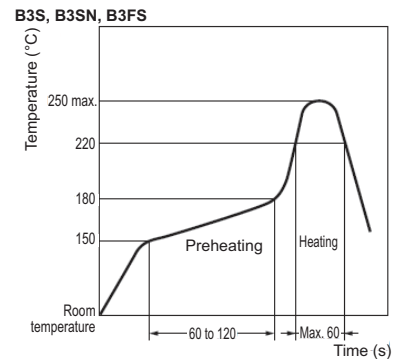

Note: The above heating curve applies if the PCB thickness is 1.6 mm.



Is soldering method appropriate?

Please refer to Soldering procedure on page E-1.

Rocker Switch

Mechanism of Failure Occurrence

Cause/reason	Possible failures when using the switch
Foreign matters such as dusts adhere to switch	<Contact failure> Contact doesn't turn ON Contact resistance value is high (unstable)
Flux adheres to switch	<Contact failure> Contact doesn't turn ON Contact resistance value is high (unstable)
Overcurrent flows to switch	<Contact failure> Contact keeps ON <Operation failure> The push button isn't switched. If the push button is switched to OFF, it turns back to ON.
The excessive soldering heat is applied to switch	<Contact failure> Contact doesn't turn ON, or keeps ON <Operation failure> Operational feeling is bad
An excessive external force is applied to the terminal of switch	<Appearance failure> The terminal fell into the case. <Operation failure> The push button doesn't switch.
Source of sulfuric gas around switch	<Appearance failure> Discoloration in the terminals <Contact failure> Contact doesn't turn ON Contact resistance value is high (unstable) <Soldering failure> Terminals cannot be soldered

A8L



A8A



A8G



A8GS



Direct causes leading to failures

Checkpoint for prevention (measures)

Foreign matters adhere on contact surface

Be sure not to adhere foreign matters when storing, mounting and using switch.

Flux adheres on contact surface

Be sure not to adhere flux on switch when soldering. Consider quick-connect terminal type.

Contact welding
Contact transition
Fusing of internal parts
Generating of carbide on contact surface

Be sure not to flow overcurrent to switch.

The resin around the contact is puffed up
The position of the contact changes

Be sure to solder within the soldering condition recommended by Omron.

The terminal falls into the case

When inserting a receptacle into a terminal, please make sure not to impose an excessive pressure on the terminal such as inserting from angle or being caught. Consider using low insertion force type of receptacle.

Sulfurization of contact surface
Sulfurization of terminal surface

Store switch under appropriate environment. Be sure to use switch in the place without source of sulfuric gas/sulfuric hydrogen gas.

[If foreign matters adhere...]

■What are the possible failures?



<Contact failure>

Contact doesn't turn ON

Contact resistance value is high (unstable)

■The failure case

- Foreign matters entered through a gap between the push button and the case, adhere to the contact and contact failure will result.

e.g.) A8L

Appearance



Foreign matters adhere the push button

Inside the case



Foreign matters enter through the gap between the push button and the case

Contact



Foreign matters adhere to the contact, and contact failure will result

■Checkpoint for prevention!



Do you find any foreign material such as dust/board powder around switch?

Since A8L, A8A, A8G, A8GS are not sealed type, it's impossible to prevent foreign matters and liquid from entering completely.

Be sure not to allow any foreign matter to adhere when storing/installing/using switches.

Because it's difficult to prevent dust from being produced, please consider using dust-proof covers etc.

For your reference, some type of A8A has a rubber cap for high dustproof (optional accessory) and has a simple dustproof.

[If flux adheres...]

■What are the possible failures?



<Contact failure>
 Contact doesn't turn ON
 Contact resistance value is high (unstable)

■The failure case

- The flux entered inside the switch, adheres to the contact surface and contact failure results.
 e.g.) A8L

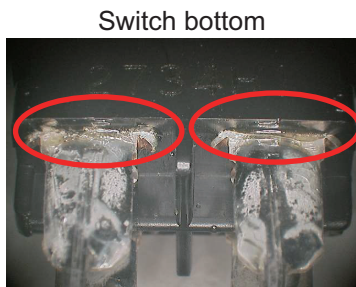

Switch bottom
 Flux adheres to the terminal base

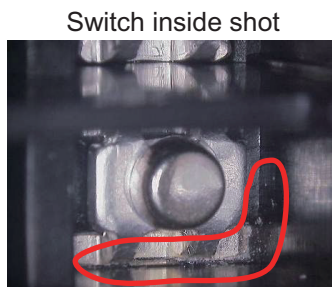

Switch inside shot
 Flux enters through the gap between the case and the terminal



Contact
 Flux adheres to the contact surface

■Checkpoint for prevention!



Is switch soldering condition under our recommended condition?

Solder switches by following the conditions below.
 Also, do not apply any force to the terminal immediately after soldering.
 Note that A8A and A8G cannot be soldered. Please use the receptacles.

Model	Soldering method	Soldering temperature	Soldering time
A8L	Automatic soldering tank	270°C	5s max.
		350°C	3s max.
	Manual soldering	420°C max. at the tip of the soldering iron	3s max.
A8GS	Manual soldering	400°C max. at the tip of the soldering iron	4s max.

●Automatic soldering tank (Flow soldering tank)

Please make sure that no flux will bubble up onto the level of the PCB.

●Manual soldering

To prevent flux from entering into switch, place the terminal horizontal or downward when soldering.

Make sure that there is 1mm or more gap between the part of the terminal covered by soldering and the surface of the case.

Also, to prevent vaporizing flux from entering into the Switch, be sure to use a smoke extractor when soldering.

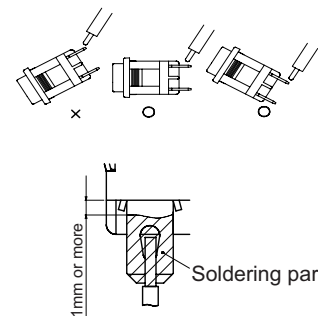

Consider quick-connect terminal type!

We have quick-connect terminal types that can connect with receptacles, so please consider it.

[If a current exceeding the rating flows...]

■What are the possible failures?



<Contact failure>

Contact keeps ON

<Operation failure>

The push button doesn't switch over

When switched to OFF, it goes back to ON

■The failure case

- The contact welders because of overcurrent, and does not open, so contact keeps ON.

e.g.) A8L

OK switch X-ray

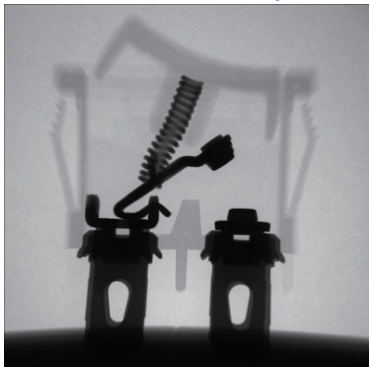

The contact is open, and it is OFF

NG switch X-ray

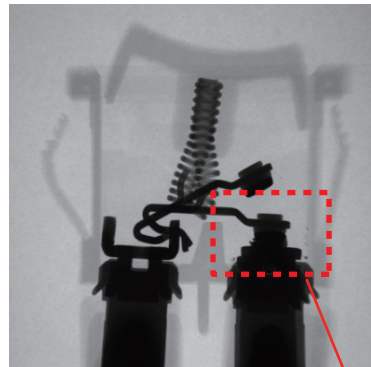

Even if the push button is pressed, the contact does not open, so the button cannot return. Also, contact keeps ON.



■ Checkpoint for prevention!



Did you use the circuit that caused over rated current to the switch?

Be sure not to flow over rated current to switch (including short-circuit current).

In addition, according to load type, there is much difference between inrush current and steady-state current and steady-state current and surge voltage, which may result in over rated current. Please make sure to properly apply the contact protective circuit.

* For your information, refer to the below examples of general contact protection circuit.

Examples of general contact protection circuit

Circuit example	Applicable current		Feature	Element selection
	AC	DC		
CR circuit		See note.	Yes	<p>Note: When AC is switched, the load impedance must be lower than the C and R impedance.</p> <p>C: 0.5 to 1 μF per switching current (1 A) R: 0.5 to 1 Ω per switching voltage (1 V) The values may change according to the characteristics of the load. The capacitor suppresses the spark discharge of current when the contacts are open. The resistor limits the inrush current when the contacts are closed again. Consider these roles of the capacitor and resistor and determine the ideal capacitance and resistance values from experimentation.</p>
		Yes	Yes	<p>The operating time will increase if the load is a relay or solenoid. It is effective to connect the CR circuit in parallel to the load when the power supply voltage is 24 or 48 V and in parallel to the contacts when the power supply voltage is 100 to 200 V.</p> <p>Use a capacitor with a dielectric strength between 200 and 300 V. When AC is switched, make sure that the capacitor has no polarity. If, however, the ability to control arcs between contacts is a problem for high DC voltage, it may be more effective to connect a capacitor and resistor between the contacts across the load. Check the results by testing in the actual application.</p>
Diode method		No	Yes	<p>Energy stored in the coil is changed into current by the diode connected in parallel to the load. Then the current flowing to the coil is consumed and Joule heat is generated by the resistance of the inductive load. The reset time delay in this method is longer than that of the CR method.</p> <p>The diode must withstand a peak inverse voltage 10 times higher than the circuit voltage and a forward current as high as or higher than the load current.</p>
Diode and Zener diode method		No	Yes	<p>This method will be effective if the reset time delay caused by the diode method is too long.</p> <p>Zener voltage for a Zener diode must be about 1.2 times higher than the power source since the load may not work under some circumstances.</p>
Varistor method		Yes	Yes	<p>This method makes use of constant-voltage characteristic of the varistor so that no high-voltage is imposed on the contacts. This method causes a reset time delay more or less. It is effective to connect varistor in parallel to the load when the supply voltage is 24 to 48 V and in parallel to the contacts when the supply voltage is 100 to 200 V.</p> <p>Select the varistor so that the following condition is met for the cut voltage V_c. For AC currents, the value must be multiplied by $\sqrt{2}$. $V_c > (\text{Current Voltage} \times 1.5)$ If V_c is set too high, however, the voltage cut for high voltages will no longer be effective, diminishing the effect.</p>

[If excessive soldering heat is applied...]

■What are the possible failures?



- <Contact failure>
 - Contact turns on or keeps turning ON
 - Conduction is not switched
- <Operation failure>
 - Operational feeling is bad

■The failure case

- If a force is applied to the terminal while excessive soldering heat is being applied, the terminal will lean and operation failure will result.

e.g.) A8L

Terminal part



The resin at the terminal base melted and the terminal fell down

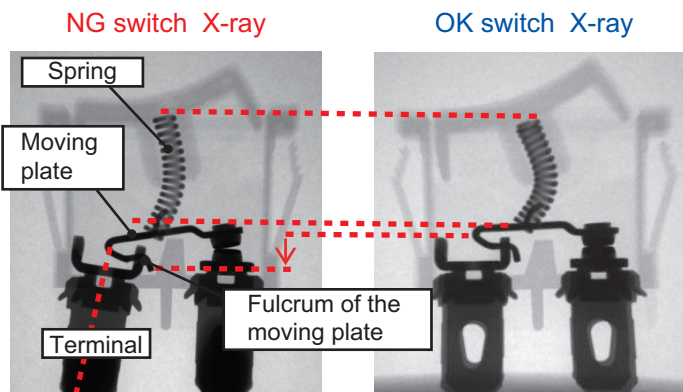

The terminal is leaning and the fulcrum of the moving plate is lowered, so it is not switched. Also, the force of the spring is low, so the operational feeling is bad (light).

■Checkpoint for prevention!



Is switch soldering condition under our recommended condition?

Solder switches by following the conditions below.

Also, do not apply any force to the terminal immediately after soldering.

Note that A8A and A8G cannot be soldered. Please use the receptacles.

Model	Soldering method	Soldering temperature	Soldering time
A8L	Automatic soldering tank	270°C	5s max.
		350°C	3s max.
	Manual soldering	420°C max. at the tip of the soldering iron	3s max.
A8GS	Manual soldering	400°C max. at the tip of the soldering iron	4s max.

[If an excessive force is applied to the terminal...]

■What are the possible failures?



- <Appearance failure>
The terminal fell into the case.
- <Operation failure>
The push button isn't switched.

■The failure case

●The switch doesn't turn OFF.

e.g.) A8L

Appearance shot

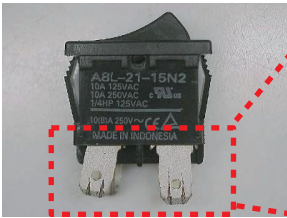

OK switch
X-ray shot (OFF)

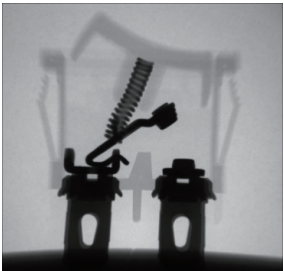

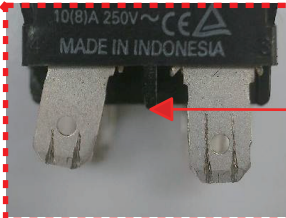

NG switch
X-ray shot (OFF)

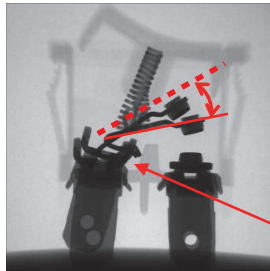

An excessive force was applied when inserting the receptacle, the terminal leaned and insert into the case.

Because the terminal is leaning, the moving plate doesn't return to the proper position.

■Checkpoint for prevention!



Be sure not to apply an excessive force when inserting a receptacle!

When inserting a receptacle, please make sure not to apply an excessive pressure to the terminal such as slanted inserting or being caught.

Please consider using low insertion force type of receptacles.

Model	Receptacle
A8L (quick-connect terminal type) A8GS (power terminal)	#187 (6.3×0.8mm)
A8A	#250 (t=0.8)
A8G	Contact terminal: #250 (t=0.8) Coil terminal: #110 (t=0.5)

[If sulfuric gas generates...]

■What are the possible failures?



<Appearance failure>

Discoloration in the terminals

<Contact failure>

Contact doesn't turn ON, contact resistance value is high (unstable)

<Other>

Terminals cannot be soldered

■The failure case

- Discoloration in the terminals due to sulfurization. It cannot be soldered.

e.g.) A8L

Terminal part shot (the progress of color change)

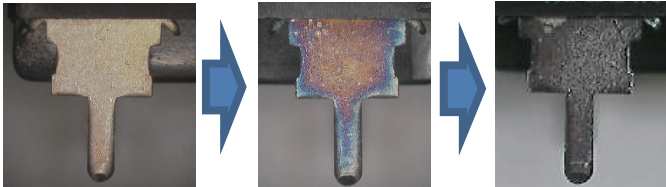

Soil color → Rust → Purplish brown → Blue → Black

Terminal after soldering



It cannot be soldered

■Checkpoint for prevention!



Are the storage environment and condition appropriate?

●Storage environment

To prevent degradation such as discoloration in the terminals during storage, do not store switches in locations that are subject to the following conditions:

- (1) High temperature or humidity
- (2) Corrosive gases
- (3) Direct sunlight

●Storage condition

Store switches in the packaging or box.

Please use switches as quickly as possible after packaging or box is opened

When storing leftover parts, make sure that appropriate measures are taken against humidity and corrosive gases.



Has sulfuric gas or sulfuric hydrogen gas existed in environment using switch?

When sulfuric gas or sulfuric hydrogen gas exists, as it will causes to occur functional disorders such as breakdown by contact

- As a source of sulfuric gas, the following example can be mentioned.

[Source]

Car exhaust gas, gypsum board, wood, papers such as cardboard, fiber scraps, seawater, dirt, sludge, volcanic gas, hot springs, etc.

[Occurrence Place]

Storage warehouse for gypsum, sewage / wastewater treatment plants, garbage disposal plants, abandoned site, petroleum refining

Also, if there is less oxygen or no oxygen, and if it is humid, we judge that sulfuric gas is generated. Injecting oxygen is the most effective to suppress the generation of sulfuric hydrogen gas. In addition, eliminating the source of gas generation and making dry state is also effective.

DIP Switch

Mechanism of Failure Occurrence

■Slide DIP Switch

A6H



A6HF



A6S-H



Cause/reason
Flux adheres to switch
The excessive soldering heat is applied to switch
The excessive external force is applied to switch
Actuator is at the middle between ON and OFF when soldering

Possible failures when using the switch
<Operation failure> The actuator is too hard to move Because the actuator is hard, it is broken when operating <Contact failure> Contact doesn't turn ON, contact resistance value is high (unstable)
<Sensitivity failure> The operating force is high <Contact failure> Contact doesn't turn ON, contact resistance value is high (unstable)
<Appearance failure> Actuator is broken <Contact failure> It doesn't turn ON
<Sensitivity failure> The operating force is low.

■Piano DIP Switch

A6HR



A6SR



A6TR



Flux adheres to switch
The excessive soldering heat is applied to switch
Lever is at the middle between ON and OFF when soldering

<Operation failure> The lever is too hard to move <Contact failure> Contact doesn't turn ON, contact resistance value is high (unstable)
<Sensitivity failure> The operating force is high <Contact failure> Contact doesn't turn ON, contact resistance value is high (unstable)
<Appearance failure> The lever is lowered <Sensitivity failure> The operating force is low.

■Rotary DIP Switch

A6K



A6KV



A6KS



A6KSV



Flux adheres to switch
Rotor is at the middle between positions when soldering
The excessive external force is applied to switch

<Operation failure> The rotor is too hard to roll <Contact failure> Contact doesn't turn ON, contact resistance value is high (unstable)
<Sensitivity failure> The operating force is low
<Appearance failure> The knob is missing

A6SN



A6T



A6TN



A6D



A6E-N



Direct causes leading to failures

Flux adheres on contact surface

Resin is melted

An external force damages a actuator or a slider

Actuator is deformed

Checkpoint for prevention (measures)

Be sure not to adhere flux on switch when soldering.
If you wash, please use a washable model.
Consider using DIP switches with knife-edge structure (A6TN, A6SN).

Be sure to solder within the soldering condition recommended by Omron.

Be sure not to apply any force on the actuator from a direction other than operating direction.
Operate the actuators at the base part.

Make sure that the actuator is set fully to either ON or OFF when soldering.

A6DR



A6FR



Flux adheres on contact surface

Resin is melted

Lever is deformed

Be sure not to adhere flux on switch when soldering.
If you wash, please use a washable model.

Be sure to solder within the soldering condition recommended by Omron.

Make sure that the lever is set fully to either ON or OFF when soldering.

A6R



A6RS



A6RV



A6A



A6C



A6CV



Flux adheres on contact surface

Rotor is deformed

An external force damages a actuator or a slider

Be sure not to adhere flux on switch when soldering.
If you wash, please use a washable model.

Make sure to set to "0" correctly when soldering.

Be sure not to apply any force from a direction other than operating direction.
Use a flat-blade screwdriver that fits into the screwdriver groove for operation.

[If flux adheres...]

■What are the possible failures?



<Operation failure>

The actuator is too hard to move

Because the actuator is hard, it is broken when operating

<Contact failure>

Contact doesn't turn ON

Contact resistance value is high (unstable)

■The failure case

●Flux adheres and the actuator doesn't move (it is broken)

e.g.) A6T

Appearance

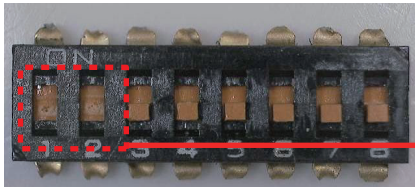

Focus

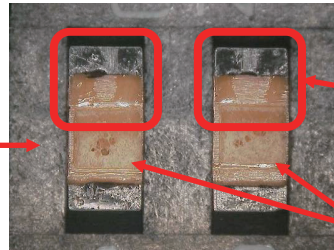

Flux firmly adheres between the cover/actuator, and the actuator doesn't move

The actuator is broken

●Flux enters inside and contact failure results

e.g.) A6T

Contact

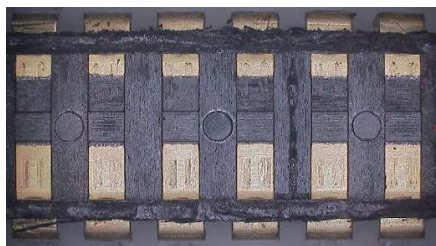

Check with UV irradiation

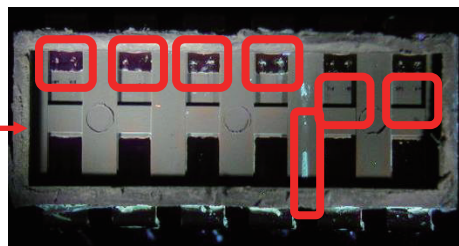

Flux adheres to the contact part

* When flux is irradiated with UV, it fluoresces.

■Checkpoint for prevention!



Please consider using DIP switches with knife-edge structure!

A6TN and A6SN have knife-edge structure (movable contacts are stuck through fixed contacts). Therefore, if flux adheres to a contact part, they penetrate a layer of flux.



Does switch soldering condition conform with our recommended condition?

Solder switches by following the conditions below.
Also, be sure not to allow flux to adhere to switch or scatter.

Model	Soldering method	Soldering temperature	Soldering time
A6T	Automatic soldering tank	260°C max.	5s max.
A6E-N A6D	Manual soldering	350°C max. at the tip of the soldering iron	3s max.
A6TN	Automatic soldering tank	265°C±5°C	8s max.
	Manual soldering	400°C max. at the tip of the soldering iron	4s max.
A6H A6HF A6S-H	Reflow soldering	Within the heating curve shown in the following diagram	
A6SN	Manual soldering	400°C max. at the tip of the soldering iron	4s max.
	Reflow soldering	Within the heating curve shown in the following diagram	

●A6HF, A6SN Heating curve

A6HR, A6HF, A6SN Soldering Conditions

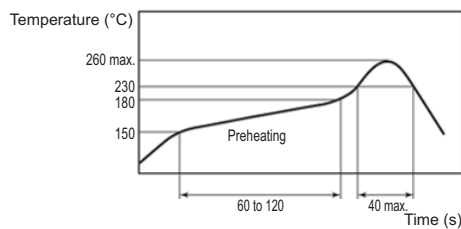

●A6S-H, A6H Heating curve

A6H, A6S-H, A6SR, A6RS, A6KS, and A6KSV Soldering Conditions

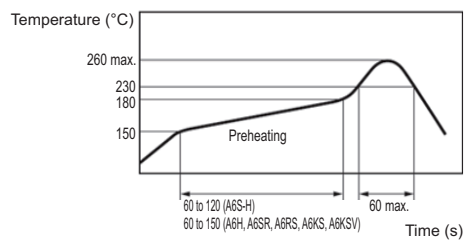

●Automatic soldering tank (Flow soldering tank)

If flux bubbles up onto PCB surface, it may enter into switch.
Please make sure that no flux will bubble up onto the level of PCB.

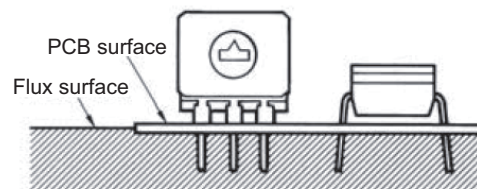

●Manual soldering

Do not solder switch more than twice, including rectification soldering.
(As for A6TN and A6SN, only once)
An interval of five minutes is required between the first and the second soldering.



Is it a washable model?

Depending on the model, washing will cause flux to enter into switch.
If you wash, please use a washable model.
Even washable models may absorb the cleaning agent through respiration as they cool down if they are washed immediately after soldering. Wait for at least three minutes after soldering before cleaning washable models.

Model	Washability
A6HF, A6TN, A6SN, A6D, A6T (with seal tape) A6S-H (with seal tape), A6H (with seal tape)	Washable
A6E-N, A6T (Standard/raised actuator) A6S-H (Standard/raised actuator), A6H (Standard/raised actuator)	Non-washable

[If excessive soldering heat is applied...]

■What are the possible failures?



<Sensitivity failure>

The operating force is high

<Contact failure>

Contact doesn't turn ON

Contact resistance value is high (unstable)

■The failure case

●Excessive heat melts the base resin when soldering

e.g.) A6T

Appearance

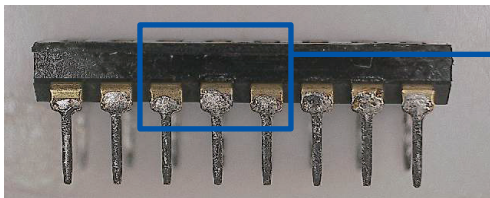

Focus

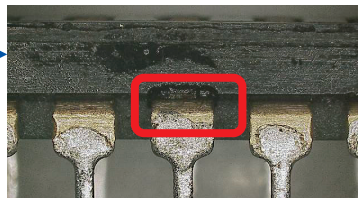

The resin at the terminal base melted

Contact shot

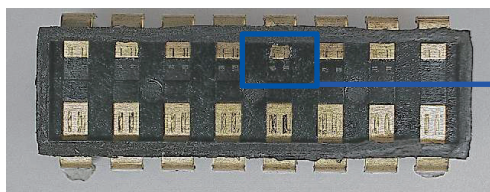

Focus

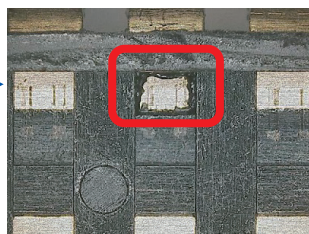

The resin around the contact part melted. The slider moves on the melted resin, and causes sensitivity failure and contact failure result.



Is switch soldering condition under our recommended condition?

Solder switches by following the conditions below.
Also, be sure not to allow flux to adhere to switch or scatter.

Model	Soldering method	Soldering temperature	Soldering time
A6T A6E-N A6D	Automatic soldering tank	260°C max.	5s max.
	Manual soldering	350°C max. at the tip of the soldering iron	3s max.
A6TN	Automatic soldering tank	265°C±5°C	8s max.
	Manual soldering	400°C max. at the tip of the soldering iron	4s max.
A6H A6HF A6S-H	Reflow soldering	Within the heating curve shown in the following diagram	
A6SN	Manual soldering	400°C max. at the tip of the soldering iron	4s max.
	Reflow soldering	Within the heating curve shown in the following diagram	

●A6HF, A6SN Heating curve

A6HR, A6HF, A6SN Soldering Conditions

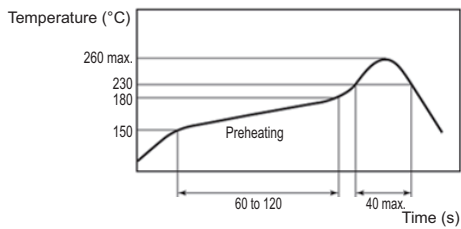

●A6S-H, A6H Heating curve

A6H, A6S-H, A6SR, A6RS, A6KS, and A6KSV Soldering Conditions

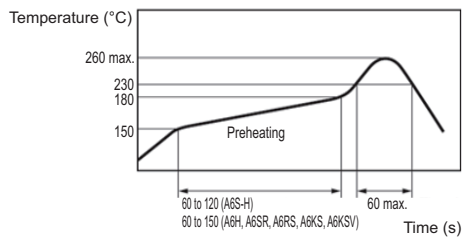

●Automatic soldering tank (Flow soldering tank)

If flux bubbles up onto PCB surface, it may enter switch.
Please make sure that no flux will bubble up onto the level of PCB.

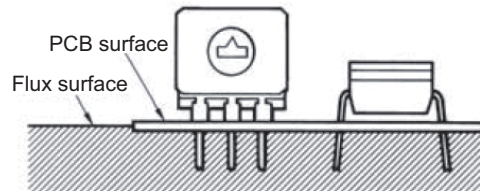

●Manual soldering

Do not solder switch more than twice, including rectification soldering.
(As for A6TN and A6SN, only once)
An interval of five minutes is required between the first and the second soldering.

[If an excessive external force is applied...]

■What are the possible failures?



<Appearance failure>
Actuator is broken
<Contact failure>
It doesn't turn ON

■The failure case

- If an excessive external force is applied to an actuator from a slanted direction/horizontally, it will damage the actuator
e.g.) A6T

Appearance

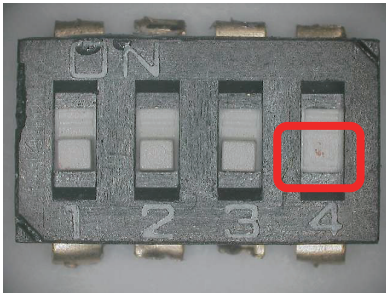

The actuator is broken

- If an excessive external force is applied to an actuator vertically, it will deform the slider
e.g.) A6H

NG switch Slider

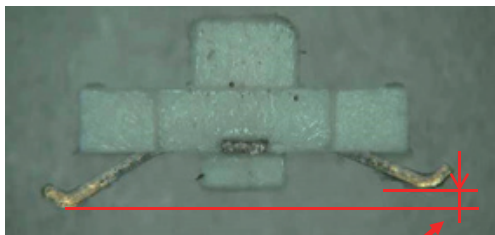

OK switch Slider

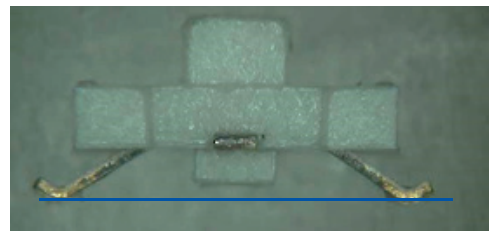

The slider is deformed

■ Checkpoint for prevention!



Is the excessive force applied to the actuator from a direction other than operating direction?

- Do not apply excessive operating force to the Switch.
Apply an operating force not exceeding 9.8 N.
- Actuator may break if it's operated from the tip.
Operate the actuators one by one at the base part so that pressure is not concentrated on the tip.
- Apply the operating force from the side of the actuator.
Do not apply a force from slanted direction or above the actuator.

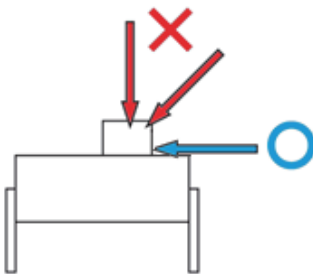

- Set switches with a tiny, rounded object, such as the tip of a ball-point pen or a small screwdriver.
- Although raised-type actuators can be operated by fingertip, do not push too hard or too fast.
- When setting or operating the A6H, use narrow-headed tweezers or similar implement (without a sharp end), to enable smooth, horizontal operation.

[If it is at the middle when soldering...]

■What are the possible failures?



<Sensitivity failure>
The operating force is low

■The failure case

- If an actuator is set at the middle when soldering, it will be deformed
e.g.) A6T

Appearance

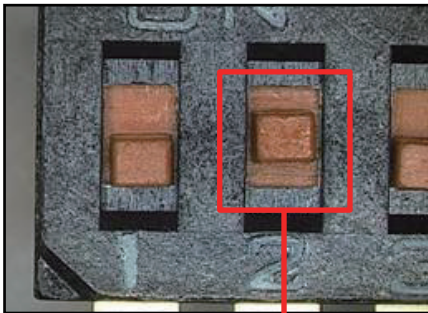

If an actuator is set at the middle between ON and OFF when soldering...

Focus_Inside

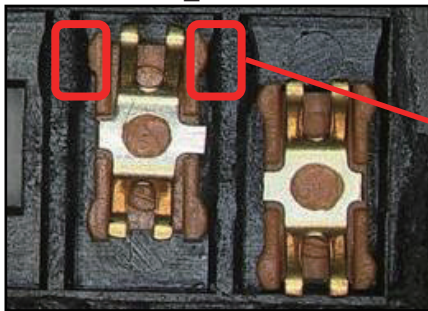

Focus on the raised part of the actuator

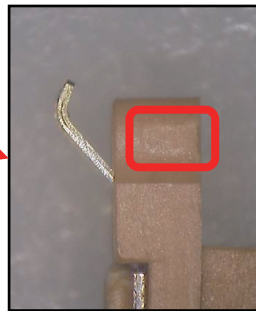

A heat is applied while the raised part of the actuator which creates sensitivity is on the raised part of the cover, which will deform the raised part of the actuator

■Checkpoint for prevention!



Is the actuator set at the middle between ON and OFF when soldering switch?

Make sure that the actuator is set fully to either ON or OFF when soldering.

For A6E-N, A6TN and A6SN models, however, always set the actuator to OFF before soldering.

[If flux adheres...]

■What are the possible failures?



- <Operation failure>
The lever is too hard to move
- <Contact failure>
Contact doesn't turn ON
Contact resistance value is high (unstable)

■The failure case

●Flux adheres and the lever doesn't move

e.g.) A6SR

Appearance

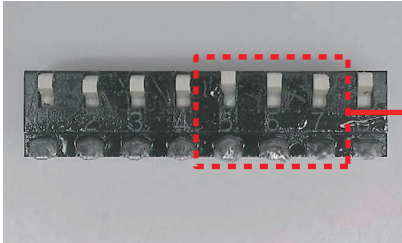

Zoom-in

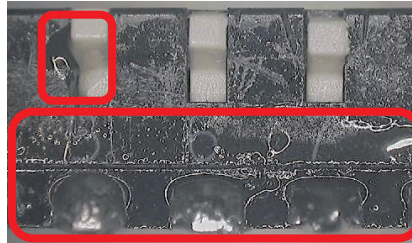

Flux firmly adheres between cover/lever, and lever doesn't move

●Flux enters inside and contact failure results.

e.g.) A6SR

Contact shot

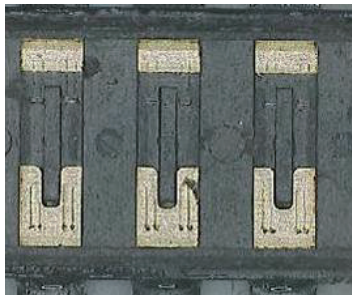

Check with UV irradiation



Flux adheres to the contact part

* When flux is irradiated with UV, it fluoresces.

■ **Checkpoint for prevention!**



Is switch soldering condition under our recommended condition?

Solder switches by following the conditions below.
Also, be sure not to allow flux to adhere to switch or scatter.

Model	Soldering method	Soldering temperature	Soldering time
A6TR A6FR A6DR	Automatic soldering tank	260°C max.	5s max.
A6DR	Manual soldering	350°C max. at the tip of the soldering iron	3s max.
A6HR A6SR	Reflow soldering	Within the heating curve shown in the following diagram	

● **A6HR Heating curve**

A6HR, A6HF, A6SN Soldering Conditions

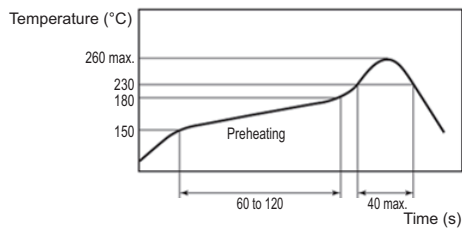

● **A6SR Heating curve**

A6H, A6S-H, A6SR, A6RS, A6KS, and A6KSV Soldering Conditions

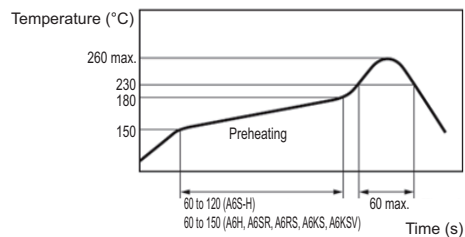

● **Automatic soldering tank (Flow soldering tank)**

If flux bubbles up onto PCB surface, it may enter into switch.
Please make sure that no flux bubble up onto the level of PCB.

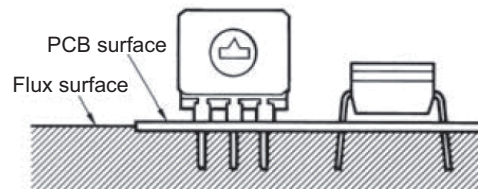

● **Manual soldering**

Do not solder switch more than twice, including rectification soldering.
An interval of five minutes is required between the first and the second soldering.



Is it a washable model?

Depending on the model, washing will cause flux to enter into switch.
If you wash, please use a washable model.
Even washable models may absorb the cleaning agent through respiration as they cool down if they are washed immediately after soldering. Wait for at least three minutes after soldering before cleaning washable models.

Model	Washability
A6DR	Washable
A6HR, A6TR, A6SR, A6FR	Non-washable

[If excessive soldering heat is applied...]

■What are the possible failures?



<Sensitivity failure>

The operating force is high

<Contact failure>

Contact doesn't turn ON

Contact resistance value is high (unstable)

■The failure case

●If excessive heat melts the base resin when soldering

e.g.) A6SR

Appearance

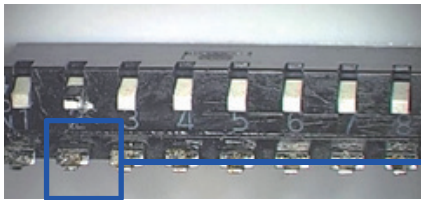

□ is zoomed in

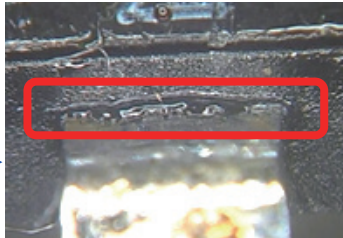

The resin at the terminal base is melted

Contact shot

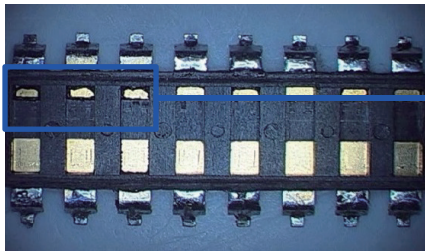

□ is zoomed in

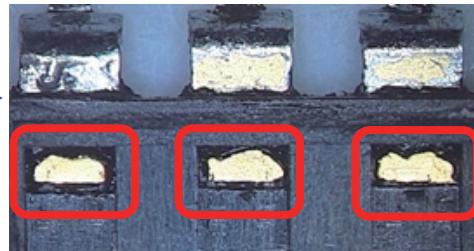

The resin around the contact part melted.
The slider runs on the melted resin and cause sensitivity failure and contact failure will result

■ **Checkpoint for prevention!**



Is switch soldering condition under our recommended condition?

Solder switches by following the conditions below.

Also, be sure not to allow flux to adhere to switch or scatter.

Model	Soldering method	Soldering temperature	Soldering time
A6TR A6FR A6DR	Automatic soldering tank	260°C max.	5s max.
A6HR A6SR	Manual soldering	350°C max. at the tip of the soldering iron	3s max.
A6HR A6SR	Reflow soldering	Within the heating curve shown in the following diagram	

● **A6HR Heating curve**

A6HR, A6HF, A6SN Soldering Conditions

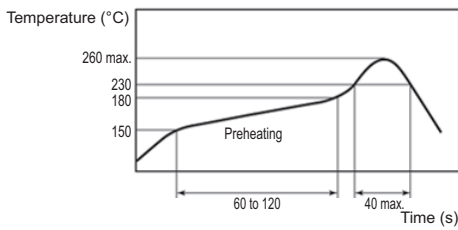

● **A6SR Heating curve**

A6H, A6S-H, A6SR, A6RS, A6KS, and A6KSV Soldering Conditions

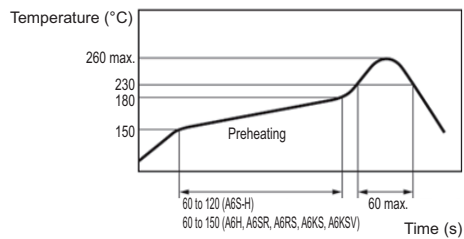

● **Automatic soldering tank (Flow soldering tank)**

If flux bubbles up onto PCB surface, it may enter into switch.

Please make sure that no flux will bubble up onto the level of PCB.

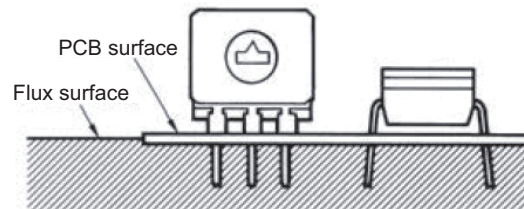

● **Manual soldering**

Do not solder switch more than twice, including rectification soldering.

An interval of five minutes is required between the first and the second soldering.

[If it is at the middle when soldering ...]

■What are the possible failures?



- <Appearance failure>
The lever is lowered
- <Sensitivity failure>
The operating force is low

■The failure case

- If a lever is set in the middle when soldering, it will be deformed.

e.g.) A6DR

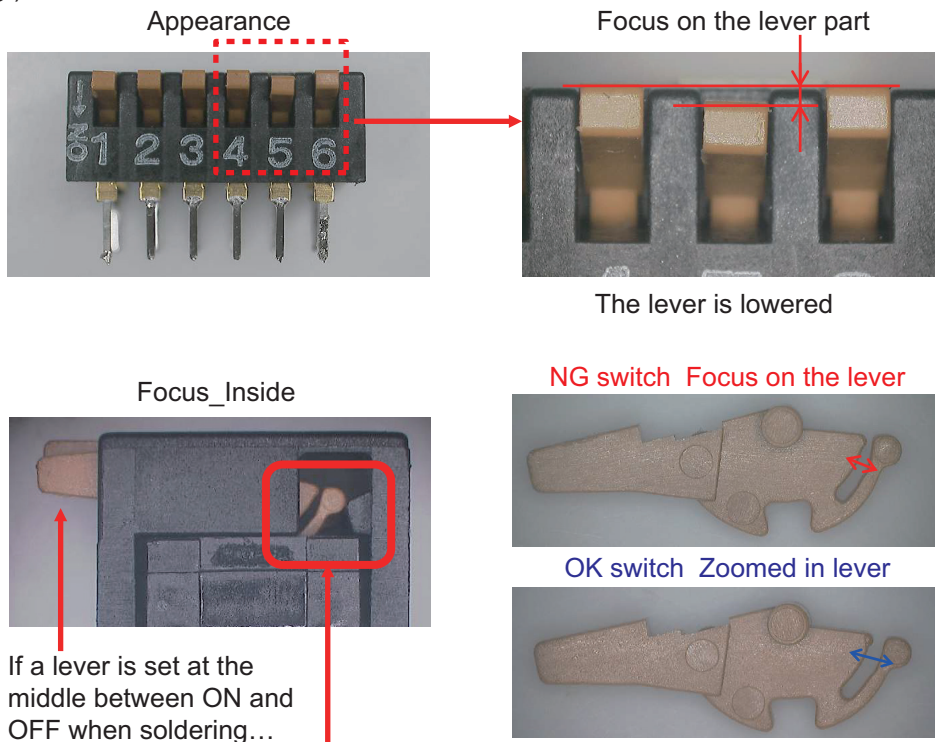

A heat is applied while the spring part of the lever which creates sensitivity is on the raised part of the cover, which will deform the spring part of the lever

■Checkpoint for prevention!



Is the lever set in the middle between ON and OFF when soldering switch?

Make sure that the lever is set fully to either ON or OFF when soldering.
For A6FR model, however, always set the lever to OFF before soldering.

[If flux adheres...]

■What are the possible failures?



- <Operation failure>
The rotor is too hard to roll
- <Contact failure>
Contact doesn't turn ON
Contact resistance value is high (unstable)

■The failure case

- Flux enters inside and contact failure may result.

e.g.) A6KV

Inside the base
(Check with UV irradiation)

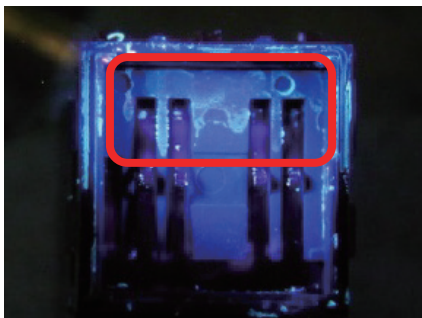

Movable contact
(Check with UV irradiation)

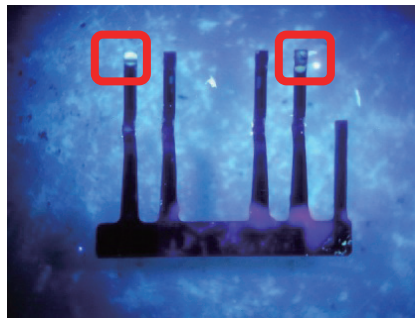

Flux adheres to the contact part

* When flux is irradiated with UV, it fluoresces.

■Checkpoint for prevention!



Is it a washable model?

Depending on the model, washing will cause flux to enter into switch.

If you wash, please use a washable model.

Even washable models may absorb the cleaning agent through respiration as they cool down if they are washed immediately after soldering. Wait for at least three minutes after soldering before cleaning washable models.

Model	Washability
A6A, A6C, A6CV,	Washable
A6R, A6RV, A6RS, A6K, A6KV, A6KS, A6KSV	Non-washable



Is switch soldering condition under our recommended condition?

Solder switches by following the conditions below.

Also, be sure not to allow flux to adhere to switch or scatter.

Model	Soldering method	Soldering temperature	Soldering time
A6A, A6C, A6CV A6R, A6RV A6K, A6KV	Automatic soldering tank	260°C max.	5s max.
	Manual soldering	350°C max. at the tip of the soldering iron	3s max.
A6RS A6KS A6KSV	Reflow soldering	Within the heating curve shown in the following diagram	

●A6RS, A6KS, A6KSV Heating curve

A6H, A6S-H, A6SR, A6RS, A6KS, and A6KSV Soldering Conditions

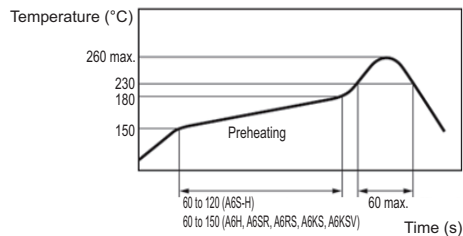

●Automatic soldering tank (Flow soldering tank)

If flux bubbles up onto PCB surface, it may enter into switch.

Please make sure that no flux will bubble up onto the level of PCB.

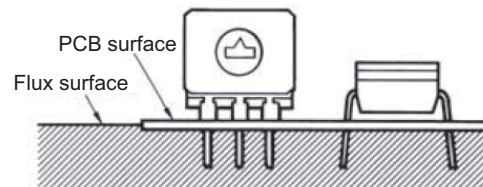

●Manual soldering

Do not solder switch more than twice, including rectification soldering.

An interval of five minutes is required between the first and the second soldering.

[If it is at the middle when soldering ...]

■What are the possible failures?



<Sensitivity failure>
The operating force is low

■The failure case

- If a rotor is set in the middle between positions when soldering, it will be deformed.

e.g.) A6A

Overall inside

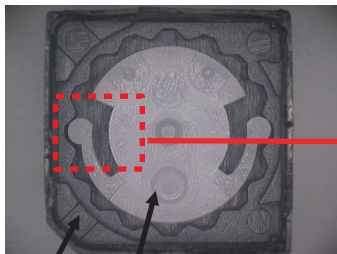

Cover
Rotor

Inside zoomed in

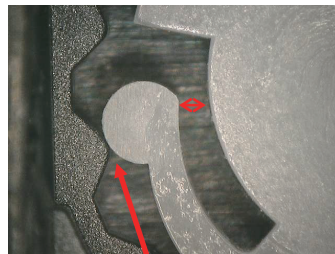

If a rotor is set in the middle between positions when soldering...
A heat is applied while the raised part of the rotor which creates sensitivity is on the raised part of the cover, which will deform the raised part of the rotor

NG switch Rotor

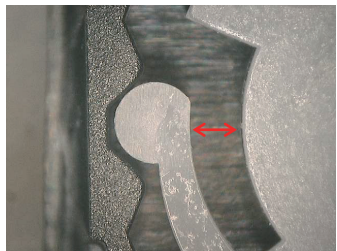

The raised part of the rotor is deformed toward inside

OK switch Rotor

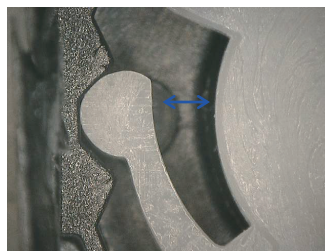

■Checkpoint for prevention!



Is the rotor set at the middle between positions when soldering switch?

Make sure to set to "0" correctly when soldering.

[If an excessive external force is applied...]

■What are the possible failures?



<Appearance failure>
The knob is missing

■The failure case

- If an excessive external force is applied, a knob goes off
e.g.) A6A

Appearance

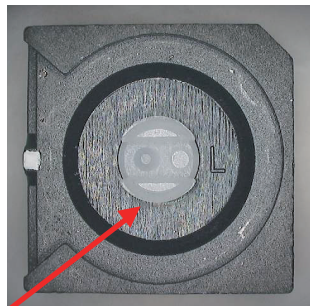
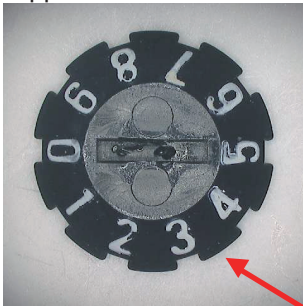

OK switch

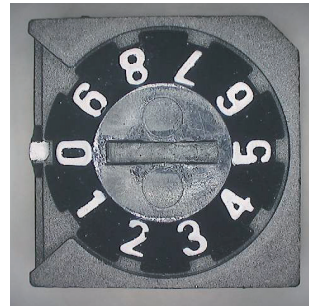

A knob is missing

■Checkpoint for prevention!



Is the excessive force applied to switch from a direction other than operating direction?

- Do not apply excessive operating force to switch.
- Please refer to the diagram below and use a flat-blade screwdriver that fits into the screwdriver groove. Using a screwdriver of inappropriate dimensions, or using a tool other than a flat-blade screwdriver may cause damage to the groove that may make the Switch impossible to operate.
- Insert the flat-blade screwdriver vertically to operate the Switch. Switch may be damaged if the screwdriver is inserted from slanting direction.

Rotary DIP Switch Operation

Models	A6K/A6KS	A6R/A6RV	A6A		A6C/A6CV
Item	Top/Side operation, flat type	Top/Side operation, flat type	Cone type, flat type	Shaft type, wheel type	Top/Side operation type
Screwdriver groove	 Depth: 0.7	 Depth: 1.0	 Depth: 0.9	 Depth: 0.9	 Depth: 1.0
Applicable screwdriver: A	1.8 to 2.1	1.8 to 2.1	3.5 to 3.8		2.0 to 2.4
Applicable screwdriver: B	0.3 to 0.45	0.7 to 0.8	0.4 to 0.5		0.5 to 0.6
Part names					

Note: All units are in millimeters unless otherwise indicated.

[Reference material: Soldering procedure]



Be sure to solder as refer to the below contents.

■If soldering to board

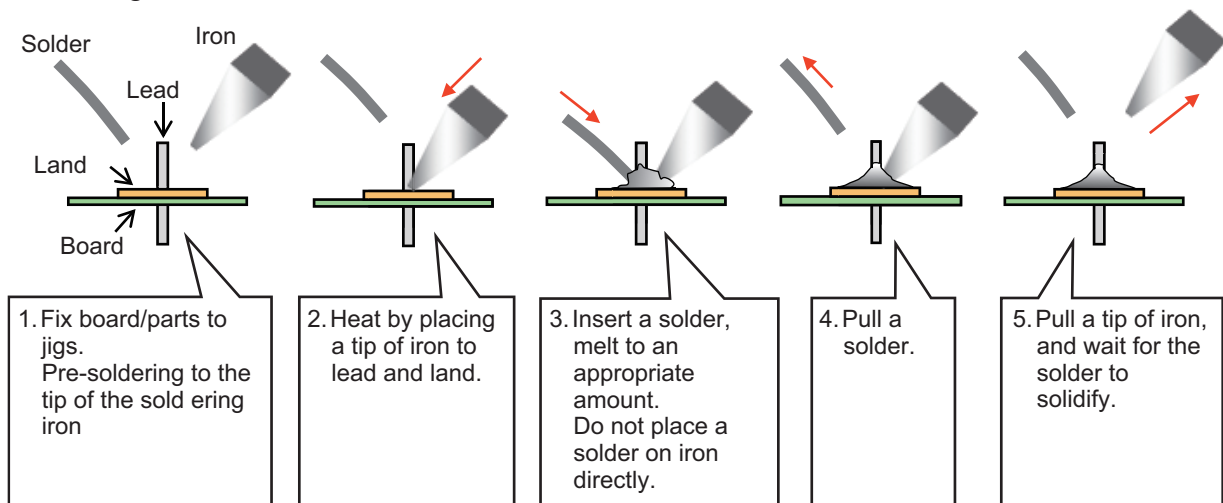

■If soldering the lead wire to terminal

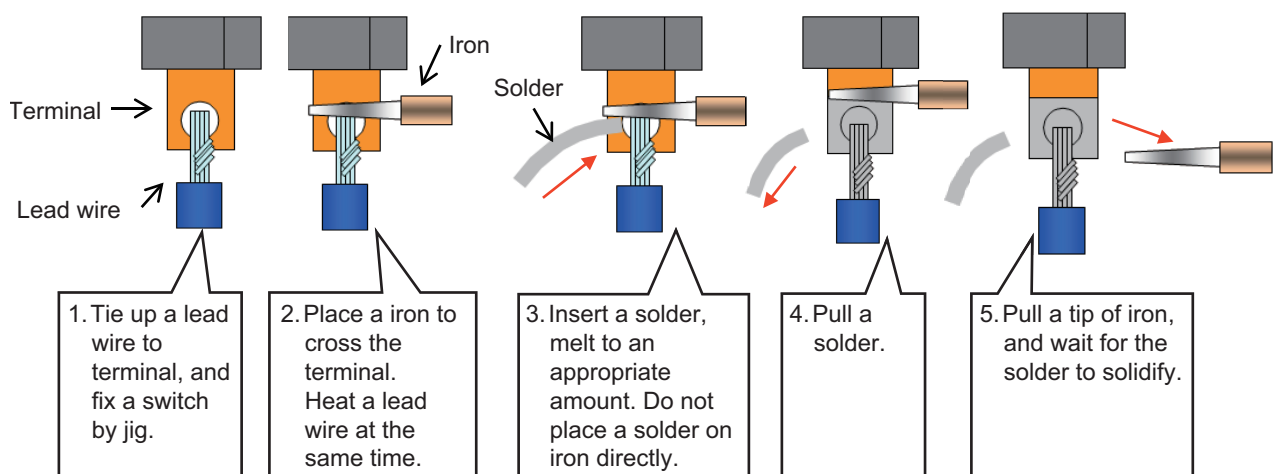

Raise a temperature for mutual base materials.

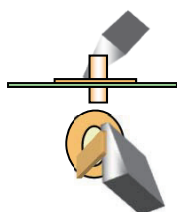

If placing an iron on solder directly, as flux scatters, melt a solder by heated base materials.

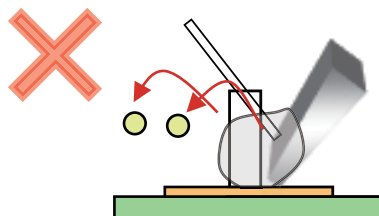

Be sure to use a smoke extractor when soldering. Be sure to clean a smoke extractor filter periodically to keep a suction power.

Please check each region's Terms & Conditions by region website.

OMRON Corporation

Electronic and Mechanical Components Company

Regional Contact

Americas

<https://www.components.omron.com/>

Asia-Pacific

<https://ecb.omron.com.sg/>

Korea

<https://www.omron-ecb.co.kr/>

Europe

<http://components.omron.eu/>

China

<https://www.ecb.omron.com.cn/>

Japan

<https://www.omron.co.jp/ecb/>